

# LINGO

## Typ F

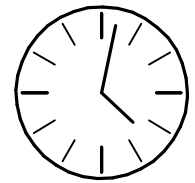

120 min

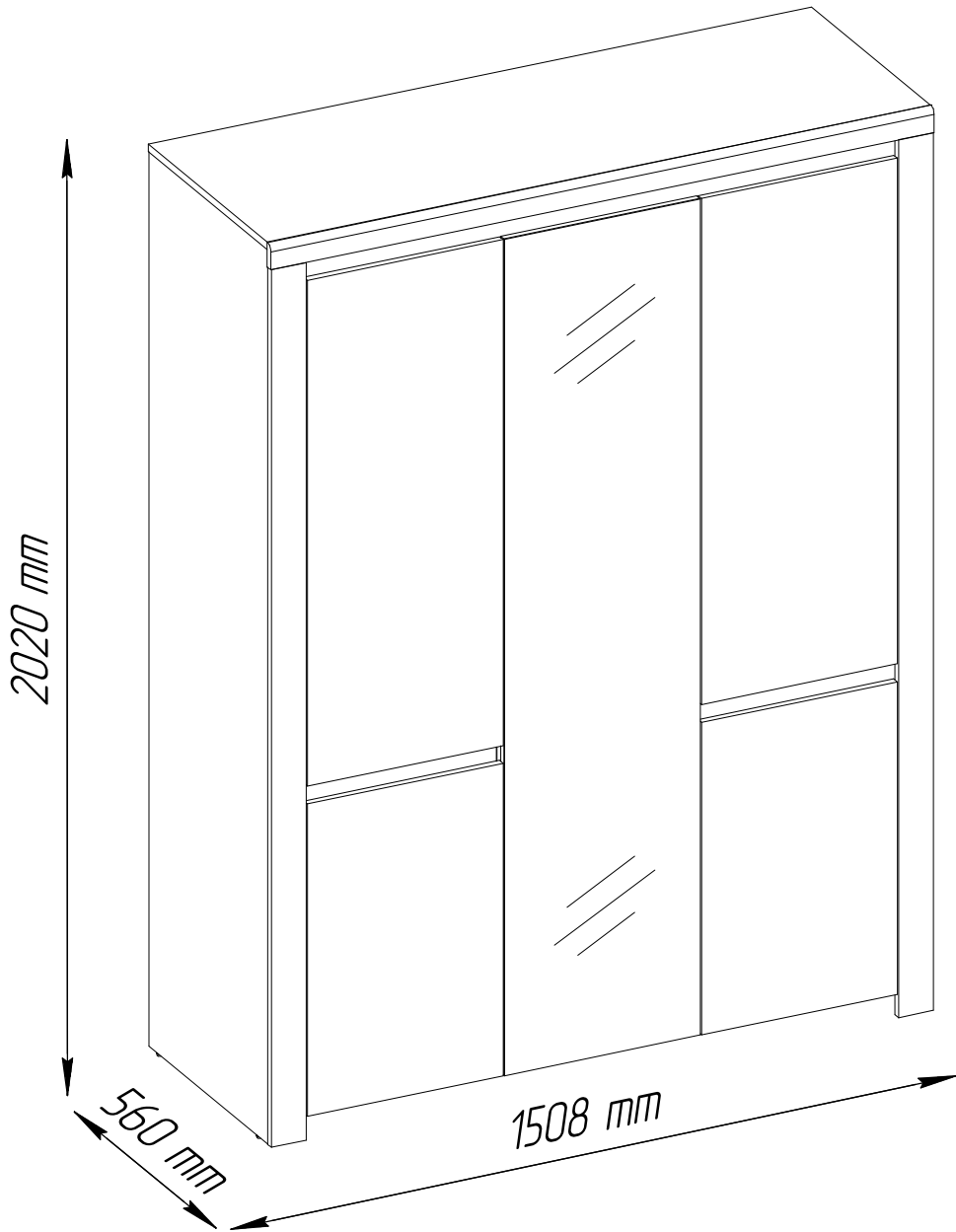
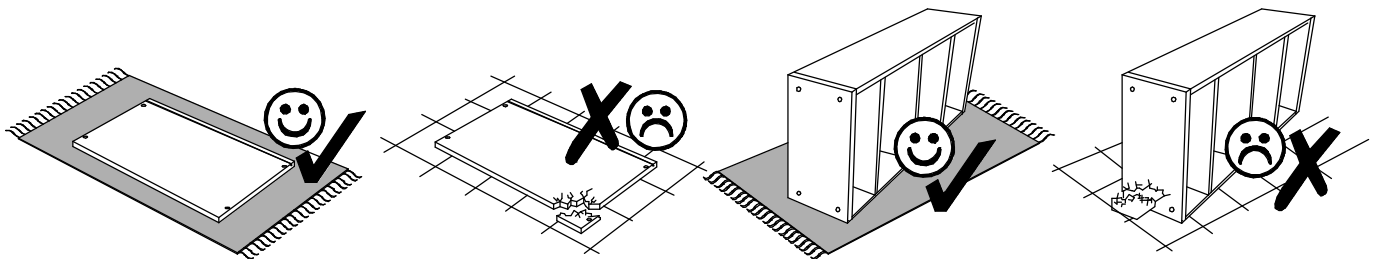
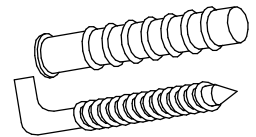
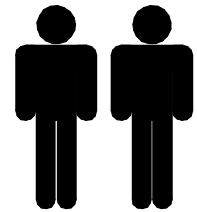

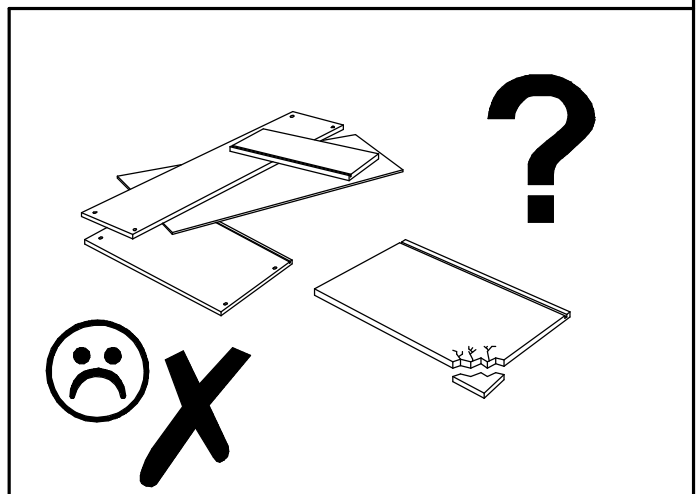
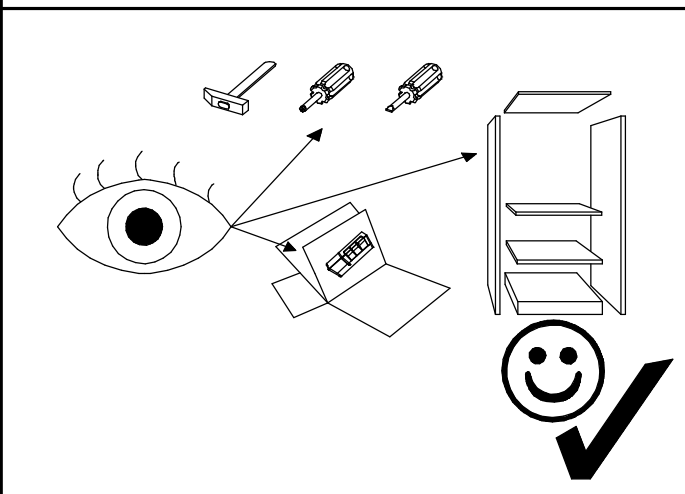
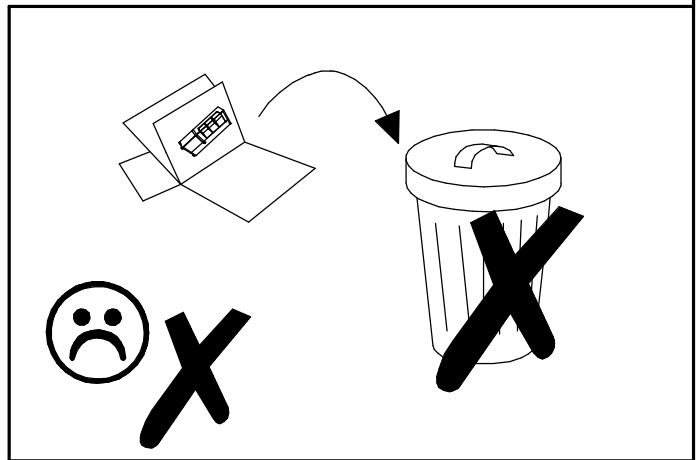
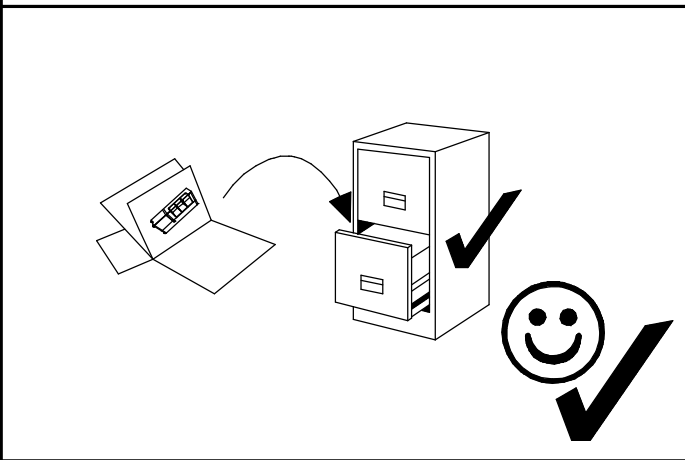
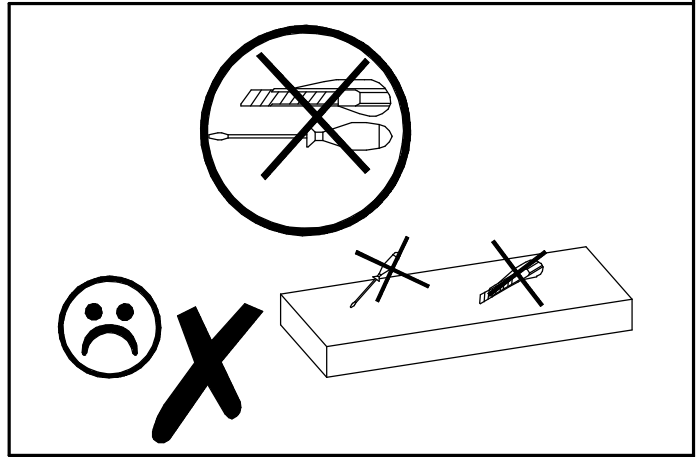
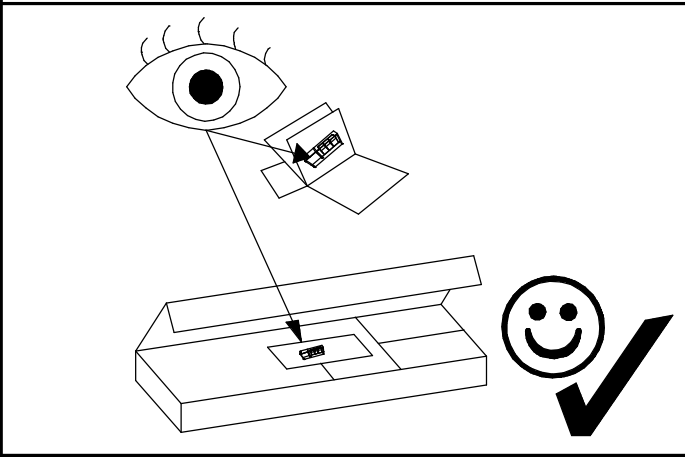

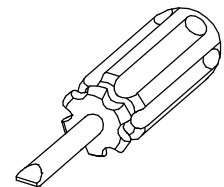
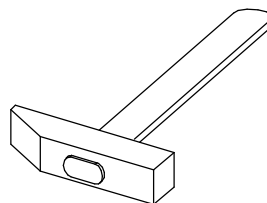
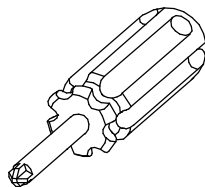
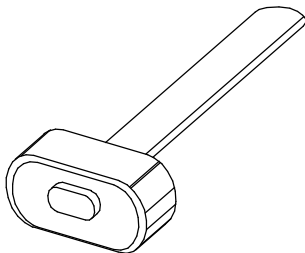
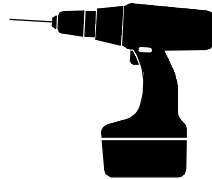
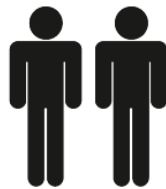
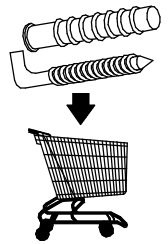
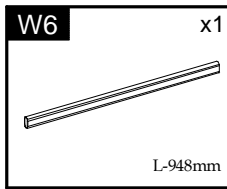
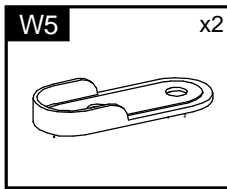
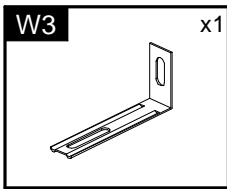
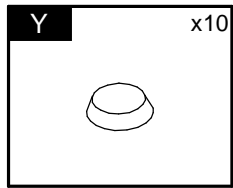
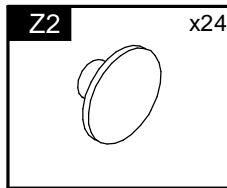
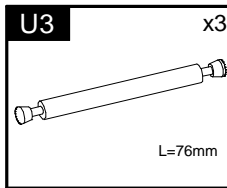
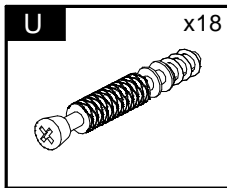
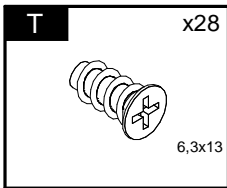
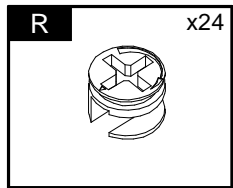
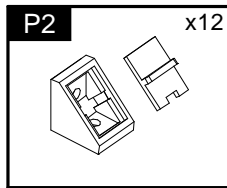
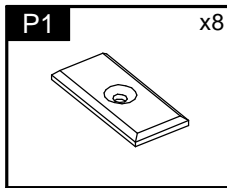
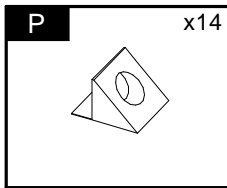
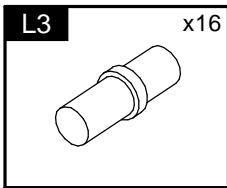
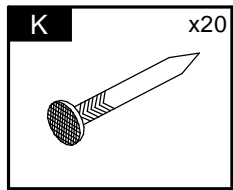
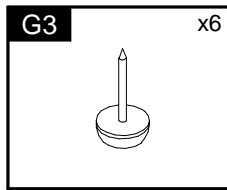
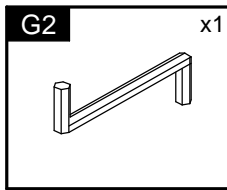
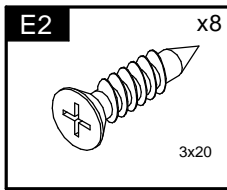
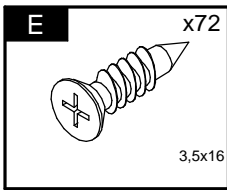
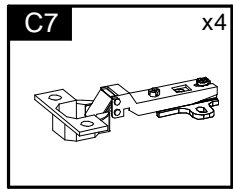
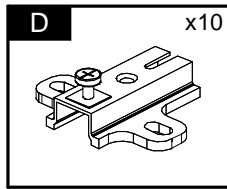
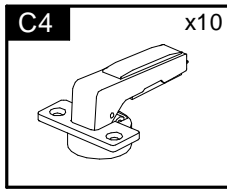
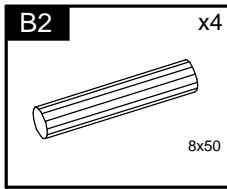
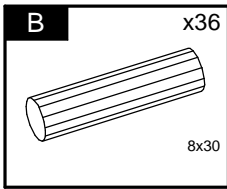
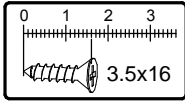

Element symbol	Measurements				Code	Paket
1	1507	540	16	1	1004	1/4
2	1998	540	16	1	1002	2/4
3	1998	540	16	1	1003	2/4
4	1932	519.5	16	1	1014/2014	3/4
5	1473	520	16	1	1005/2005	1/4
6	250	50	16	1	1007	1/4
7	952.5	519	16	1	1015	1/4
8	952.5	519	16	1	N/A	1/4
9	504.5	519	16	1	1008	1/4
10	504.5	519	16	1	N/A	1/4
11	504.5	519	16	1	N/A	1/4
12	504.5	519	16	1	N/A	1/4
13	1473	65	16	1	1013	1/4

Element symbol	Measurements				Code	Paket
14	504.5	65	16	1	1010	1/4
15	952.5	65	16	1	1017	2/4
16	1866.5	445	16	1	1022	3/4
17	1953	519	3	1	N/A	2/4
18	1953	483.5	3	2	N/A	2/4
19	1131	447	16	1	1021/3001	4/4
20	1131	447	16	1	1021/3002	4/4
21	699	447	16	1	1022/3003	4/4
22	699	447	16	1	1022/3004	4/4
23	1961	82	16	1	1004/3005	2/4
24	1961	82	16	1	1004/3006	2/4
25	1510	56.5	19	1	1034/3007	3/4

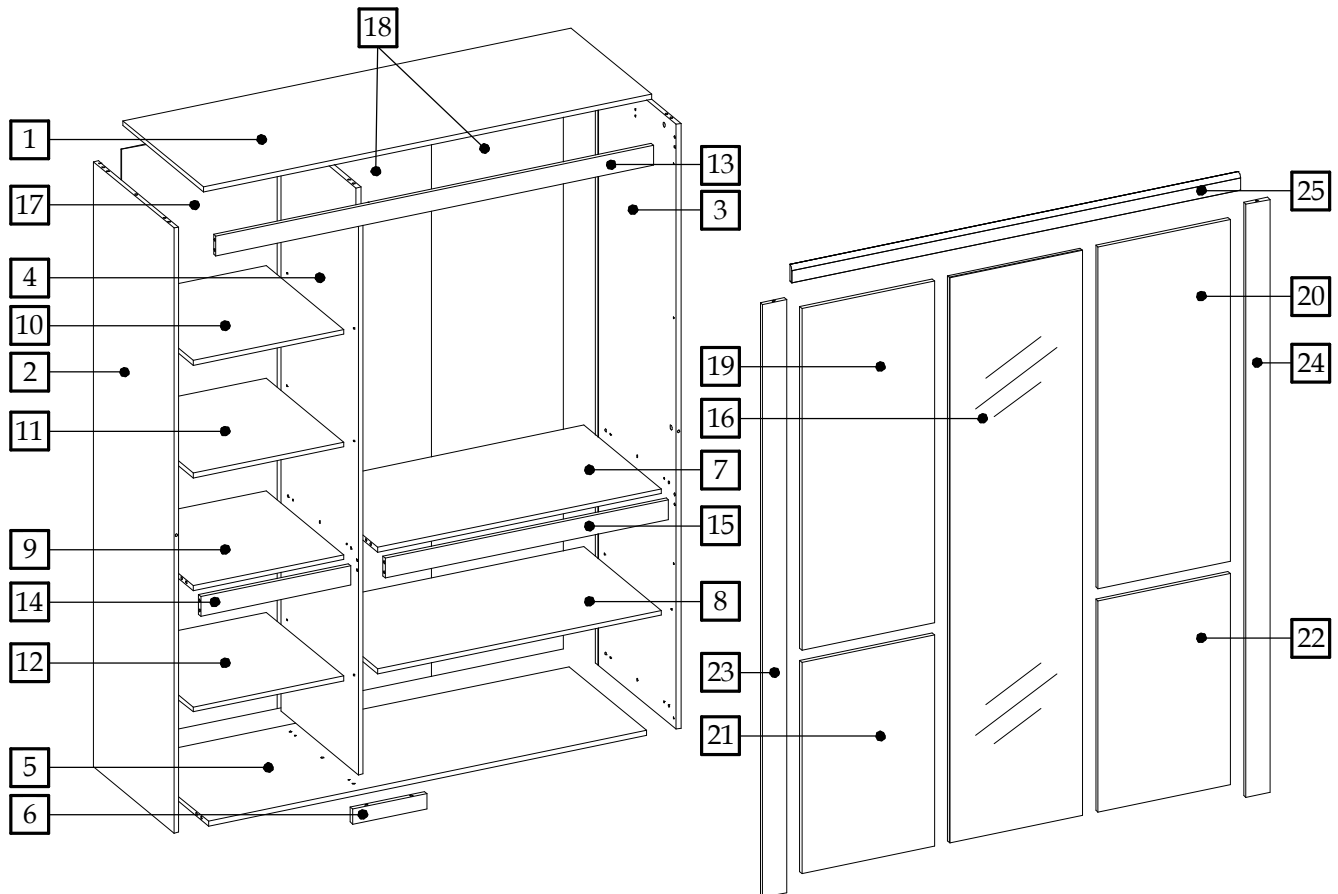

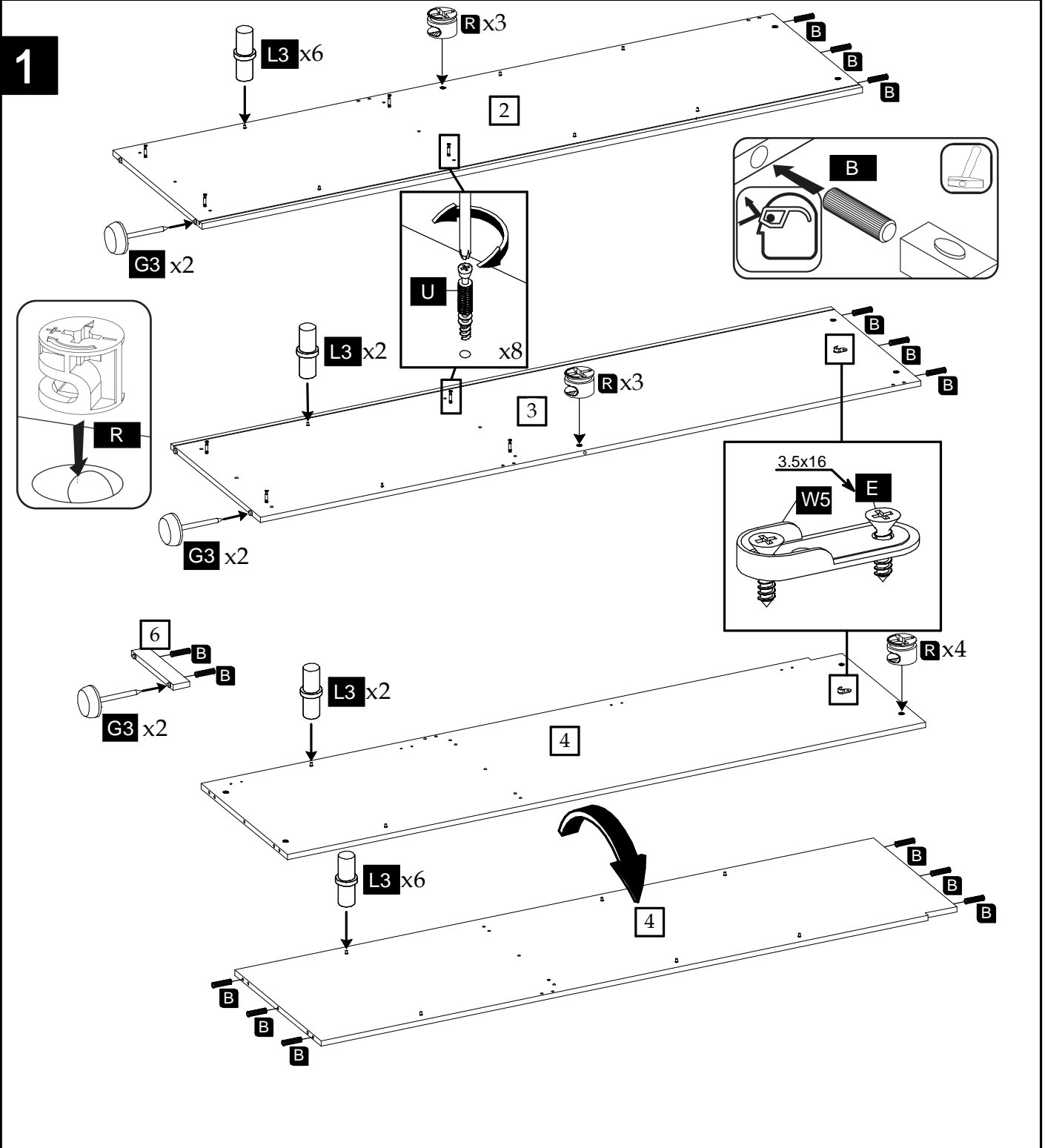
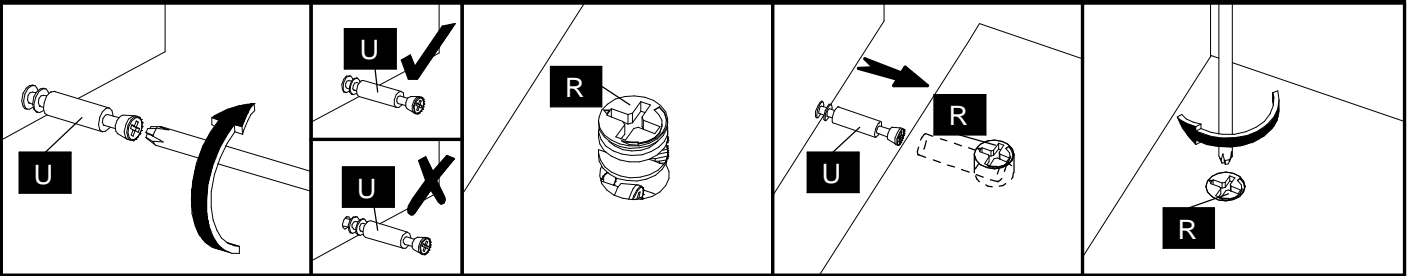

2

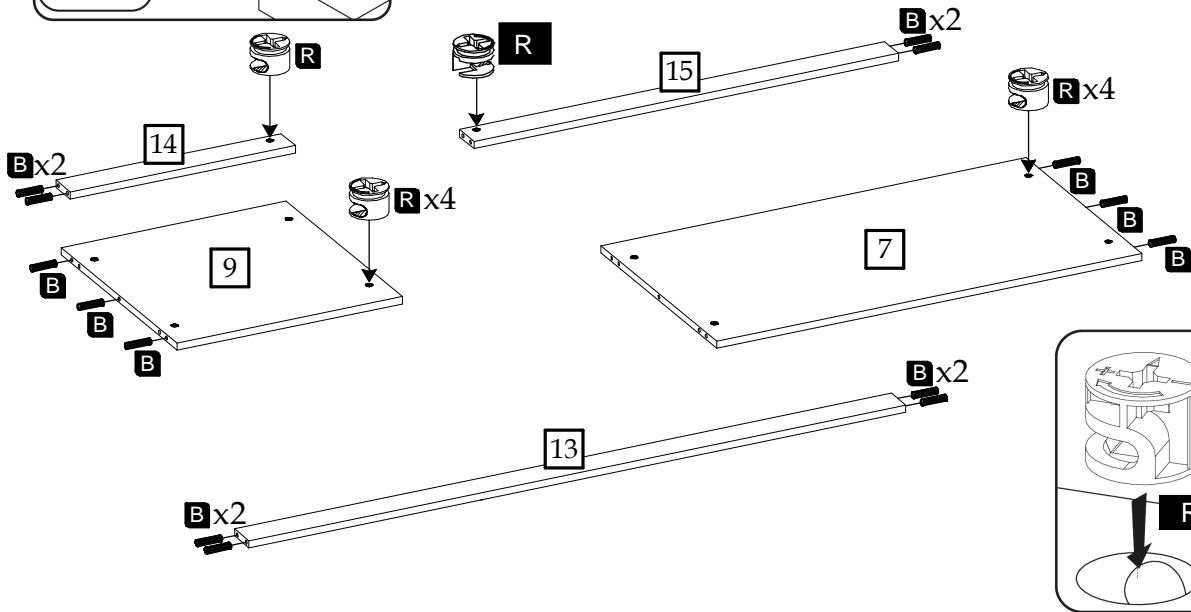
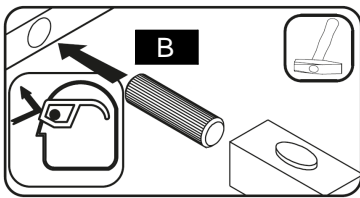

3

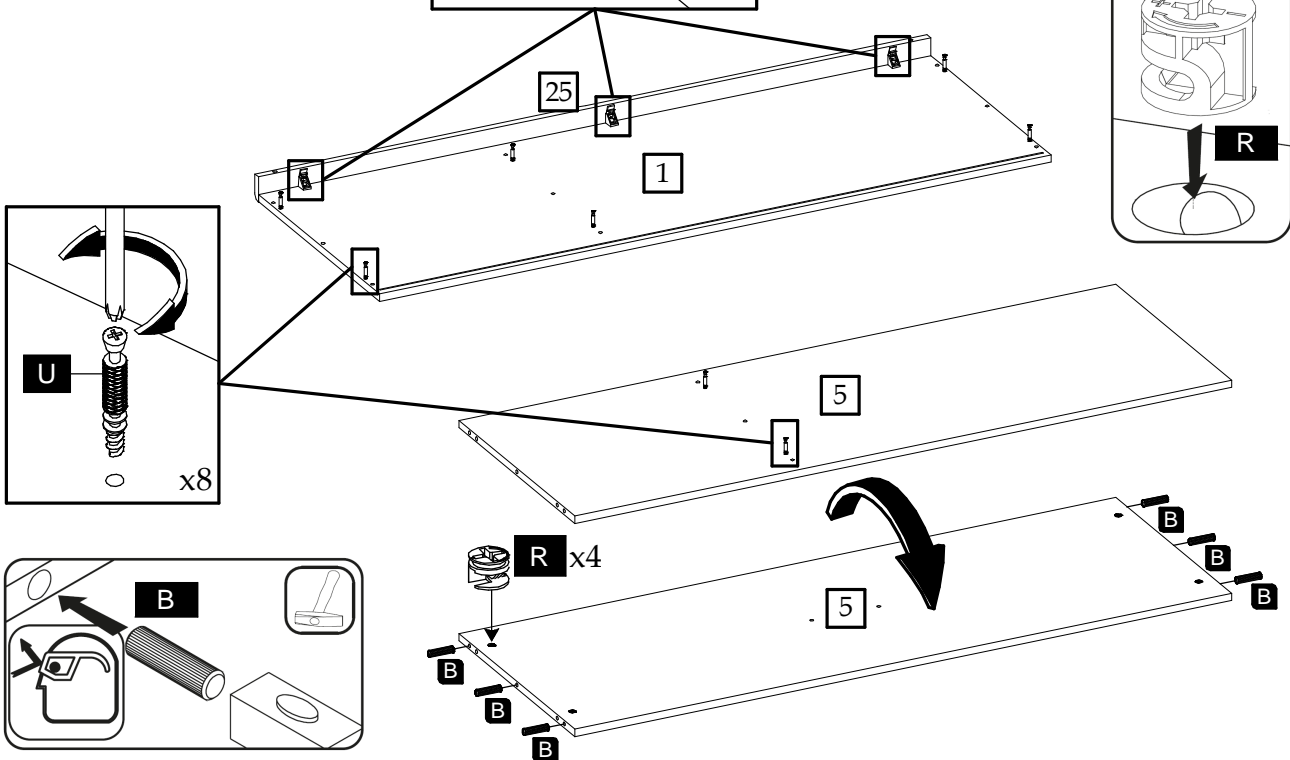
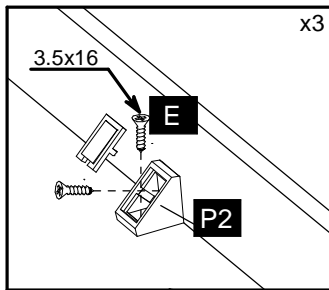

4

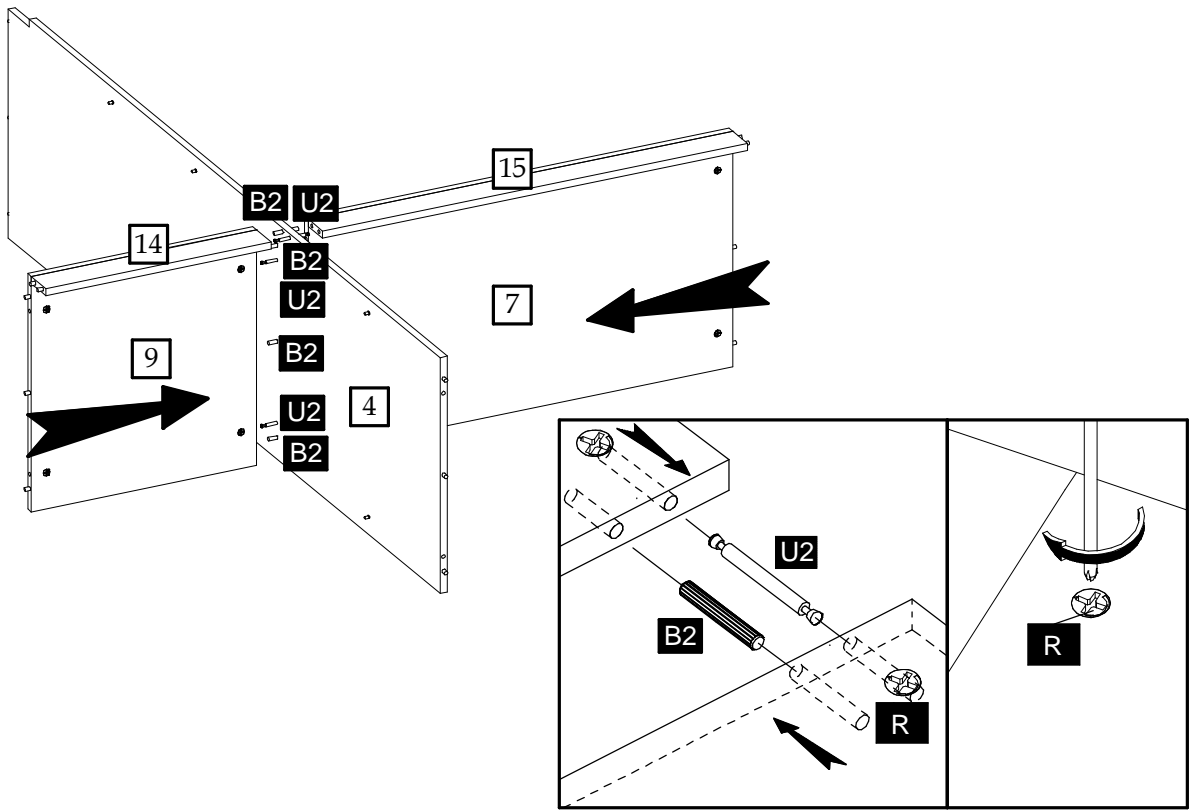

5

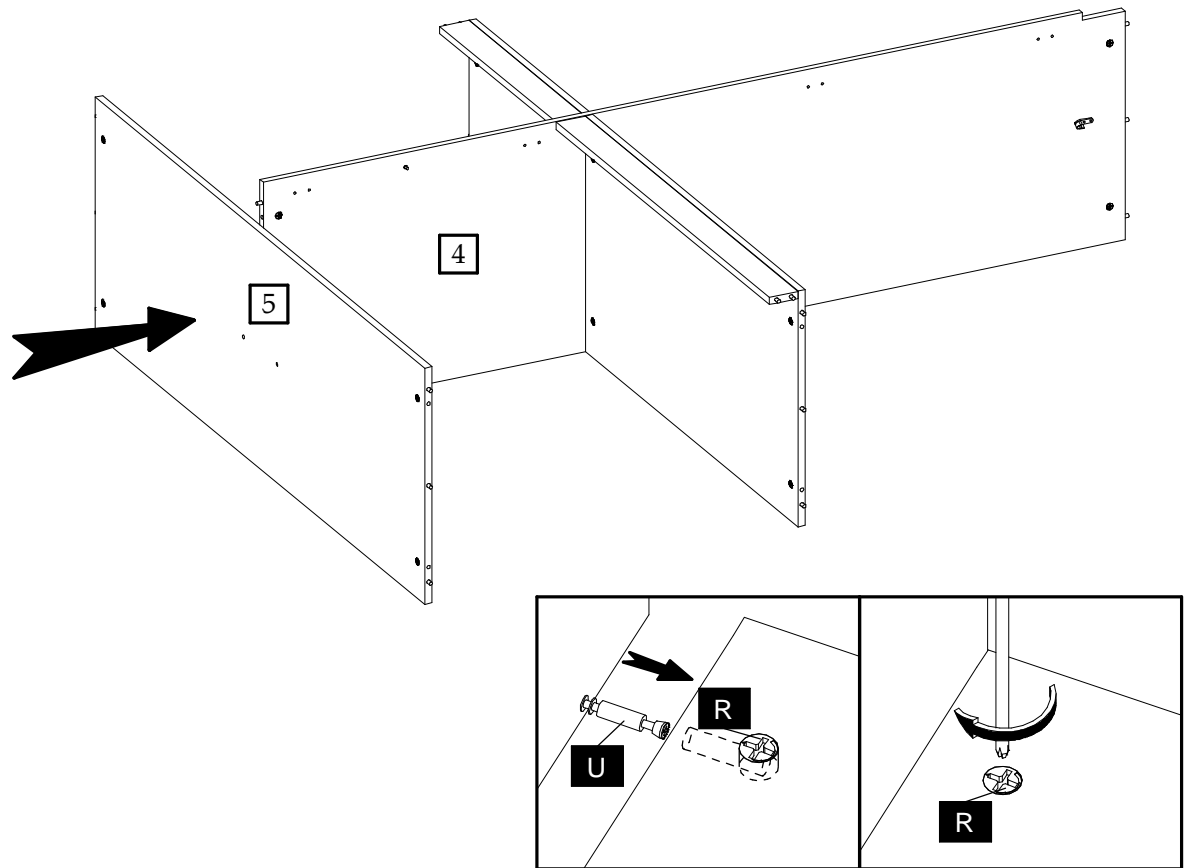

6

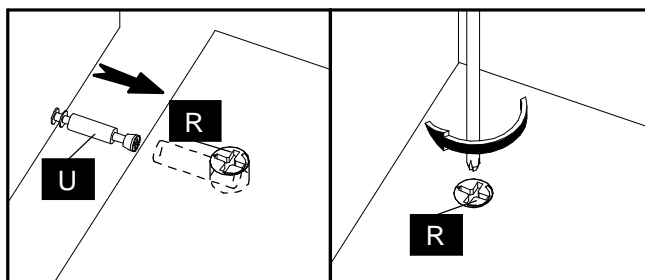
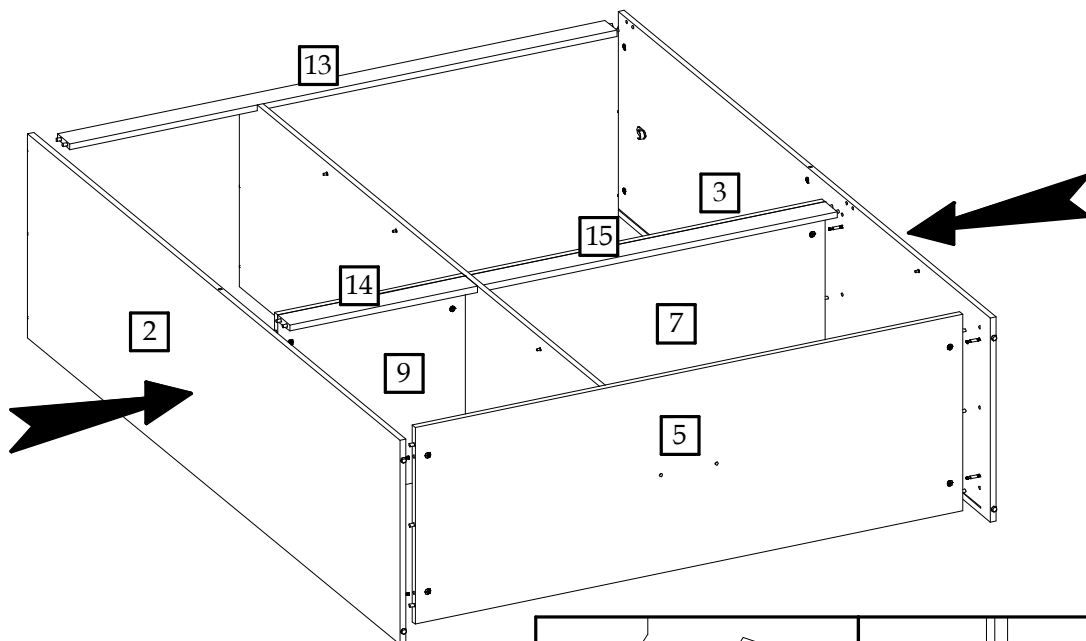

7

